



## PATIENT INFORMATION LEAFLET

### SCHEDULING STATUS

S4

**Evrysdi®**; powder for oral solution 0,75 mg/mL

The active substance is risdiplam

Contains sodium benzoate 1,5 % (m/v) as a preservative

Contains sugar – sucralose 16 mg & mannitol 1344,70 mg

Contains antioxidant – ascorbic acid 14,10 mg

### Read all of this leaflet carefully before you start taking Evrysdi

- Keep this leaflet. You may need to read it again.
- If you have further questions, please ask your doctor or pharmacist.
- Evrysdi has been prescribed for you only. Do not pass it on to others. It may harm them, even if their signs of illness are the same as yours.

### What is in this leaflet

1. What Evrysdi is and what it is used for
2. What you need to know before you take Evrysdi
3. How to take Evrysdi
4. Possible side effects
5. How to store Evrysdi
6. Contents of the pack and other information

#### 1. What Evrysdi is and what it is used for

##### What Evrysdi is

Evrysdi contains the active substance 'risdiplam', which is a selective SMN2 gene splicing modifier.



Risdiplam can increase the amount of functional survival motor neuron (SMN) protein throughout the body.

### **What is Evrysdi used for**

Evrysdi is used for treat a genetic disease called 'spinal muscular atrophy' (SMA). It can be used in patients from 2 months of age.

### **What spinal muscular atrophy is**

SMA is caused by a shortage of a protein called 'survival motor neuron' (SMN) in the body. If you do not have enough SMN protein, you lose motor neurons. This leads to muscle weakness and wasting. This may affect everyday movements such as head and neck control, sitting, crawling and walking. The muscles used for breathing and swallowing may also be affected.

### **How Evrysdi works**

Evrysdi works by helping the body produce more functional SMN protein. This means less motor nerves are lost, which may improve muscle strength and function in people across a broad range of ages and SMA types.

In infants with SMA, Evrysdi may improve survival, preserve swallowing, and reduce the need for hospitalization and ventilator supported breathing. In children (toddlers to adolescents) and adult, Evrysdi may maintain or improve motor function over time.

## **2. What you need to know before you take Evrysdi**

### **Do not take Evrysdi:**

- If you are allergic to risdiplam or any of other other ingredients of this medicine.
- If you or your partner are pregnant or are planning to become pregnant

If you are not sure, talk to your medical practitioner or pharmacist before you take Evrysdi.

## Warnings and precautions

Talk to your medical practitioner, nurse or pharmacist before taking Evrysdi.

Treatment with Evrysdi may harm your unborn baby or may affect male fertility. See “**Pregnancy, contraception, breast-feeding and male-fertility**” in this section for more information.

## Other medicines and Evrysdi

Tell your doctor or pharmacist if you are taking, have recently taken or might take any other medicines in the future.

## Pregnancy, contraception, breast-feeding and male fertility

### Pregnancy

- If you are pregnant, think you may be pregnant or are planning to have a baby, ask your medical practitioner or pharmacist for advice before taking this medicine. This is because taking this medicine while you are pregnant could harm your unborn baby.
- Before you start treatment with Evrysdi, your medical practitioner may do a pregnancy test. This is because Evrysdi may harm your unborn baby. Your doctor will consider the benefit of you taking Evrysdi against the risk to your baby.
- If you do become pregnant during your treatment with Evrysdi, tell your medical practitioner straight away. You and your medical practitioner will decide what is best for you and your unborn baby.

### Contraception

*For women*

Do not become pregnant

- during your treatment with Evrysdi and
- for one month after you stop taking Evrysdi.



Talk to your medical practitioner about reliable methods of birth control that you and your partner should use during treatment and for one month after you stop treatment.

#### *For men*

If your female partner is of childbearing potential, you need to avoid pregnancy. Use condoms during your treatment with Evrysdi and continue to use condoms 4 months after treatment has finished.

#### **Breast-feeding**

Do not breast-feed while taking this medicine. This is because Evrysdi may pass into breast milk and may therefore harm your baby.

Discuss with your doctor if you should stop breast-feeding while taking Evrysdi.

#### **Male fertility**

Evrysdi may affect male fertility. For your family planning, ask your medical practitioner for advice.

Do not donate sperm during your treatment and for 4 months after your last dose of Evrysdi.

#### **Driving and using machines**

Evrysdi is unlikely to affect your ability to drive and use machines.

#### **Evrysdi contains sodium**

Evrysdi contains a small amount of sodium (salt) – there is less than 1 mmol (23 mg) sodium even at the highest daily dose of 5 mg (6.6 mL of 0,75 mg/mL oral solution). This means it is essentially 'sodium-free' and can be used by people on a sodium-restricted diet.

### **3. How to take Evrysdi**

Always take this medicine exactly as your doctor or pharmacist has told you. Check with your doctor or pharmacist if you are not sure.



You must also carefully read and follow the enclosed “Instructions for use” Booklet on how to take or give Evrysdi.

### **When and how to take Evrysdi**

- Evrysdi is a liquid, and is referred to as a ‘solution’ or ‘medicine’ in this leaflet.
- Take Evrysdi once daily at approximately the same time each day. This will help you remember when to take your medicine.
- You can take Evrysdi with or without food.

### **How much Evrysdi to take**

- **Adolescents and adults:** The daily dose of Evrysdi is 5 mg (6,6 mL of the 0,75 mg/mL oral solution).
- **Infants and children:** Your doctor will work out daily dose of Evrysdi based on your child’s age and weight.

**You must take your daily dose as instructed by your doctor.** Do not change the dose without speaking to your doctor.

If you do not swallow the full dose, or vomit after taking a dose of Evrysdi, do not taking a dose of Evrysdi, do not take an extra dose. Instead, just take the next dose at the usual time the next day.

### **Read the ‘Instructions for use’ Booklet**

You can find a separate “**Instructions for use**” **Booklet** in the pack. This booklet gives detailed instructions on how to prepare your dose volume with the re-usable oral syringe provided, and take the medicine either:

- by mouth, or
- through a gastrotomy tube, or
- through a nasogastric tube.



### **How long to take Evrysdi for**

Your doctor will tell you how long to take Evrysdi for. Do not stop treatment with Evrysdi unless your doctor tells you to.

### **If you take more Evrysdi than you should**

If you take more Evrysdi than you should, talk to a doctor or go to hospital straight away. Take the medicine pack and this leaflet with you.

### **If you forget to take Evrysdi**

- If it is within 6 hours of when you normally take Evrysdi, take the missed dose as soon as you remember.
- If it is over 6 hours from when you normally take Evrysdi, skip the missed dose and then take your next dose at the usual time. Do not take a double dose to make up for a forgotten dose.

## **4. Possible side effects**

Evrysdi can have side effects

Not all side effects reported for Evrysdi are included in this leaflet. Should your general health worsen or if you experience any untoward effects while taking Evrysdi, please consult your doctor, pharmacist or other healthcare professional advice.

### **Frequent side effects**

- diarrhoea
- rash

### **Reporting of side effects**

If you get any side effects, talk to your doctor or pharmacist or nurse. This includes any possible side effects not listed in this leaflet. You can also report side effects directly via the national reporting system listed in Appendix V.\* By reporting side effects you can help provide more



information on the safety of this medicine.

## 5. How to store Evrysdi

- Keep this medicine and the re-usable oral syringes out of the sight and reach of children.
- Do not store the powder for oral solution above 25 °C.
- Store the oral solution in a refrigerator (between 2°C and 8°C). Do not freeze.
- Keep the medicine in the original bottle.
- Keep the oral solution in the original amber bottle and keep bottle in an upright position with the cap tightly closed.
- Once transferred from the bottle to the oral syringe, use Evrysdi straight away. Do not store the Evrysdi solution in the syringe.
- The oral solution is stable for 64 days after constitution. The pharmacist will write the date of expiration on the bottle label and on the original carton after "Discard after". Do not use the solution past this "Discard after" date.

Do not throw away any medicines via wastewater or household waste. Ask your pharmacist how to throw away medicines you no longer use. These measures will help protect the environment.

## 6. Contents of the pack and other information

### What Evrysdi contains

- The active substance in the oral solution is 'risdiplam'.
- Each mL of the constituted oral solution contains 0.75 mg risdiplam.
- The other ingredients are mannitol (E421), isomalt, strawberry flavor, tartaric acid (E334), sodium benzoate (E211, 0.38mg/mL), macrogol/polyethylene glycol 6000, sucralose, ascorbic acid (E300), disodium edetate dehydrate

### What Evrysdi looks like and contents of the pack

- Each bottle contains 60 mg risdiplam in 2.0 g powder for oral solution.
- When constituted to a greenish yellow to yellow, strawberry flavored oral solution by your



pharmacist, the volume of the solution is 80 mL.

- Each carton contains 1 bottle, 1 press-in bottle adapter, 2 plastic 6 mL oral syringes and 2 plastic 12 mL oral syringes.

### **Holder of Certificate of Registration**

Roche Products (Pty) Ltd

90 Bekker Road, Hertford Office Park,

Building E, Vorna Valley, Midrand,

Johannesburg, 1686

South Africa

Roche Ethical Assistance Line (REAL) toll-free: 0800 21 21 25

### **This leaflet was last revised on**

Registration date: 23 August 2022

### **Registration number**

55/17.3/0466





## Instructions for Use – Administration

### Evrysdi 0.75 mg/ml powder for oral solution

#### Risdiplam

Be sure to read and understand this **Instructions for Use** before you start using Evrysdi for information on how to prepare and give Evrysdi through an oral syringe, gastrostomy tube (G-tube), or nasogastric tube (NG-tube).

If you have any questions about how to use Evrysdi, contact your medical practitioner or pharmacist.

Evrysdi should come as a liquid in a bottle when you receive it. **Do not** use if the medicine in the bottle is a powder and contact your pharmacist.

#### **Important information about Evrysdi**

- Ask your medical practitioner or pharmacist to show you the correct syringe you should use and how to measure your prescribed daily dose.
- Always use the re-usable oral syringes provided in the pack to measure your prescribed daily dose. The oral syringe protects the medicine from light.
- Two oral syringes of each size are provided in case one is lost or damaged. Contact your medical practitioner or pharmacist if both oral syringes are lost or damaged. They will advise you on how to continue to take your medicine.
- See “**How to select the correct oral syringe to use for your prescribed dose volume of Evrysdi**” for the correct oral syringe, you should use. Ask your pharmacist if you have questions on how to select the right oral syringe.
- If the bottle adapter is not in the bottle, do not use Evrysdi and then contact your pharmacist.
- **Do not** use Evrysdi after **the Discard after** date written on the bottle label. Ask your

pharmacist for the **Discard after** date if it is not written on the bottle label.

- **Do not** mix Evrysdi into food or liquids.
- **Do not** use Evrysdi if the bottle or oral syringes are damaged.
- **Avoid** getting Evrysdi on your skin. If Evrysdi gets on your skin, wash the area with soap and water.
- If you spill Evrysdi, dry the area with a dry paper towel and clean thereafter with soap and water. Throw away the paper towel in the waste and wash your hands well with soap and water.
- If there is not enough Evrysdi left in the bottle for your prescribed dose, discard the bottle with remaining Evrysdi and used oral syringes according to your local requirements; use a new bottle of Evrysdi to obtain your prescribed dose volume. **Do not mix** Evrysdi from the new bottle with the bottle you are currently using.

**Each EVRYSDI carton contains (See figure A):**

1. 1 Evrysdi bottle with bottle adapter and cap
2. 2 Oral syringes 6 mL (in pouches)
3. 2 Oral syringes 12 mL (in pouches)
4. 1 Instructions for Use booklet (not shown)
5. 1 Professional Information (not shown)

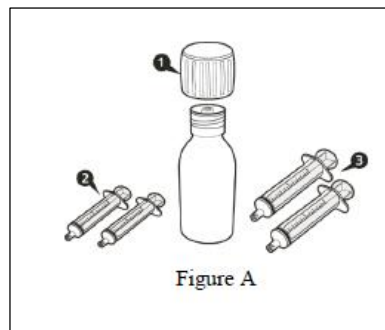

**How to store Evrysdi**

Please see section 5 “How to store Evrysdi” of the Professional Information for full information.

**A. Preparing and withdrawing your dose volume**

**How to select the correct oral syringe to use for your prescribed dose volume of Evrysdi**

- If your prescribed dose volume of Evrysdi is between 1 mL and 6 mL, use a 6 mL oral syringe (grey label)
- If your prescribed daily dose volume of Evrysdi is 6.2 mL or higher, use a 12 mL oral syringe (brown label)

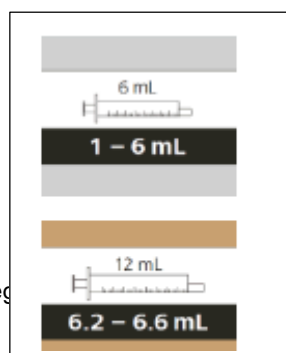

## How to prepare your dose volume of Evrysdi

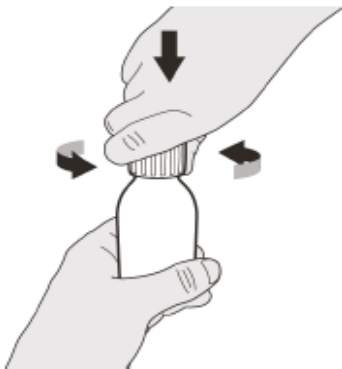

Figure B

### Step A1

Remove the cap by pushing it down and then twisting the cap to the left (counter-clockwise)  
(See Figure B). Do not throw away the cap

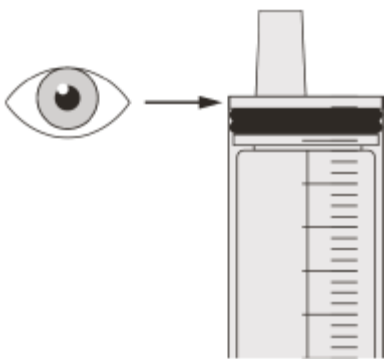

Figure C

### Step A2

Push the plunger of the oral syringe all the way down to remove any air in the oral syringe (See Figure C)

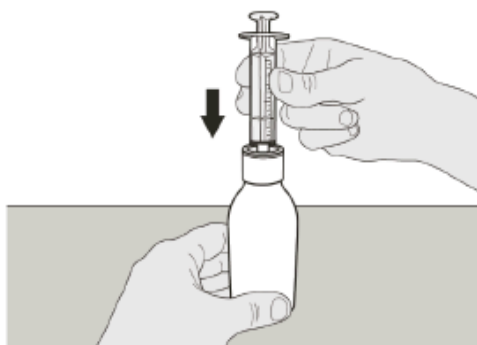

Figure D

### Step A3

Keeping the bottle in an upright position, insert the syringe tip into the bottle adapter (See Figure D).

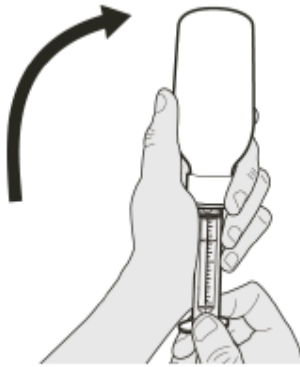

Figure E

#### Step A4

Carefully turn the bottle upside down with the syringe tip firmly inserted into the bottle adapter (See Figure E).

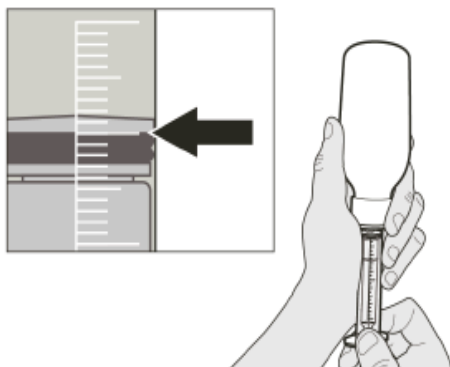

Figure F

#### Step A5

Slowly pull back on the plunger to withdraw your prescribed dose volume of Evrysdi. The top of the black plunger stopper must line up with the mL marking on the oral syringe for your prescribed daily dose volume (See Figure F). After the correct dose is withdrawn, **hold the plunger in place to keep the plunger from moving.**

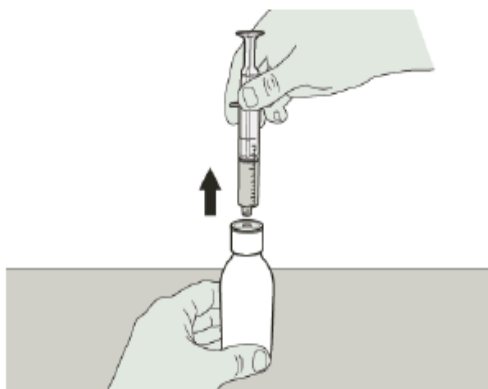

Figure G

#### Step A6

**Continue to hold the plunger in place to keep the plunger from moving.** Leave the oral syringe in the bottle adapter and turn the bottle to an upright position. Place the bottle onto a flat surface. Remove the oral syringe from the bottle adapter by gently pulling straight up on the oral syringe (See Figure G).

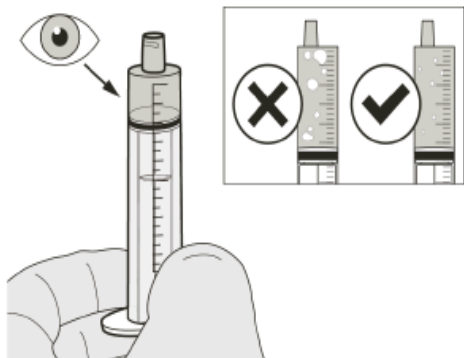

Figure H

### Step A7

Hold the oral syringe with the syringe tip pointing up. Check the medicine in the oral syringe. If there are larger air bubbles in the oral syringe (See Figure H) or if you have drawn up the wrong dose volume of Evrysdi, insert the syringe tip firmly into the bottle adapter. Push the plunger all the way down so that the medicine flows back into the bottle and repeat Steps A4 through A7.

**Take or give Evrysdi immediately after it is drawn up into the oral syringe.**

If it is not taken **within 5 minutes**, discard from oral syringe and prepare a new dose.

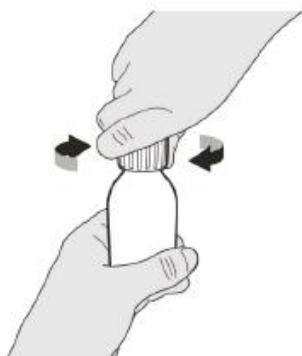

Figure I

### Step A8

Put the cap back on the bottle. Turn the cap to the right (clockwise) to tightly close the bottle (See Figure I). Do not remove the bottle adapter from the bottle

If you are taking your dose volume of Evrysdi by mouth, follow the instructions in “**B) How to take a dose volume of Evrysdi by mouth**”

If you are taking your dose volume of Evrysdi through a gastrostomy tube, follow the instructions in “**C) How to give a dose volume of Evrysdi through a gastrostomy tube**”.

If you are taking your dose volume of Evrysdi through a gastrostomy tube, follow the instructions in “D) How to give a dose volume of Evrysdi through a nasogastric tube”.

### **B. How to take a dose volume of Evrysdi by mouth**

Sit upright when taking a dose volume of Evrysdi by mouth



Figure J

#### **Step B1**

Place the oral syringe into the mouth **with the tip along either cheek.**

**Slowly** push the plunger all the way down to give the full dose of Evrysdi (See Figure J).

**Giving Evrysdi into the throat or too fast may cause choking.**

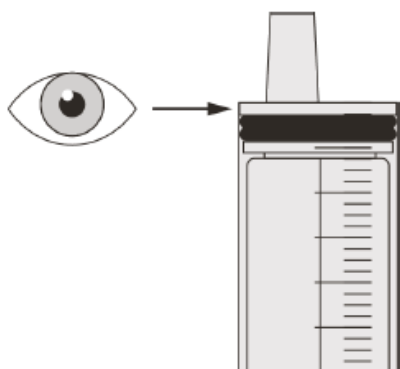

Figure K

#### **Step B2**

Check that there is no medicine left in the oral syringe (See Figure K).



Figure L

#### **Step B3**

**Drink** some water right after taking the prescribed dose of Evrysdi (See Figure L).

**Go to Step E for cleaning of the syringe.**

### **C. How to give a dose volume of Evrysdi through a gastrostomy tube**

If you are giving Evrysdi through a gastrostomy tube, ask your medical practitioner to show you how to inspect the gastrostomy tube before giving Evrysdi.

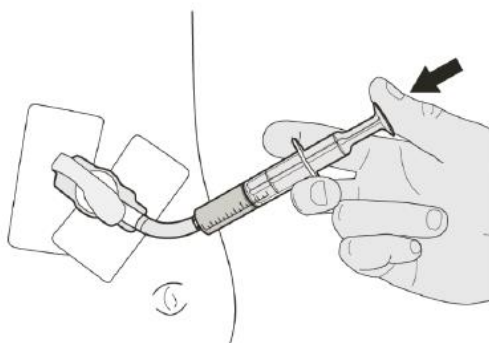

Figure M

**Step C1**

Place the oral syringe tip into the gastrostomy tube. Slowly push the plunger all the way down to give the full dose of Evrysdi (See Figure M).

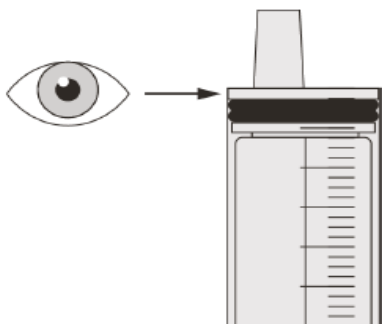

Figure N

**Step C2**

Check that there is no medicine left in the oral syringe (See Figure N).

**D. How to give a dose volume of Evrysdi through a nasogastric tube**

If you are giving Evrysdi through a nasogastric tube, ask your medical practitioner to show you how to inspect the nasogastric tube before giving Evrysdi.



Figure P

**Step D1**

Place the oral syringe tip into the nasogastric tube. Slowly press the plunger all the way down to give the full dose of Evrysdi (See Figure P).

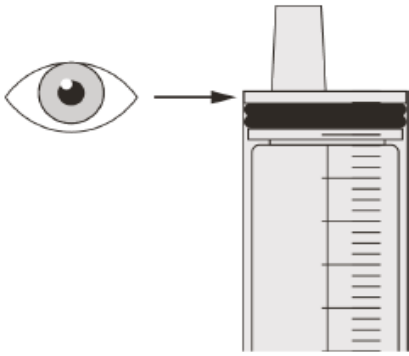

Figure Q

**Step D2**

Check that there is no medicine left in the oral syringe (See Figure Q).



Figure R

**Step D3**

Flush the nasogastric tube with 10-20 mL of water right after giving the prescribed dose of Evrysdi (See Figure R).

**Go to Step E for cleaning of the syringe**

**E. How to clean the oral syringe after use**

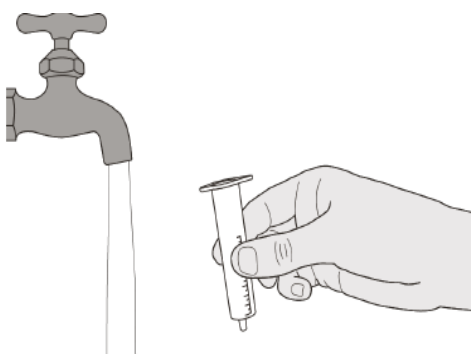

Figure S

**Step E1**

Remove the plunger from the oral syringe.

Rinse the oral syringe barrel well under clean water (See Figure S).



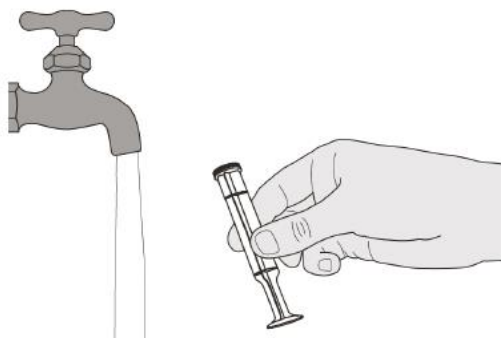

Figure T

**Step E2**

Rinse the plunger well under clean water (See Figure T).

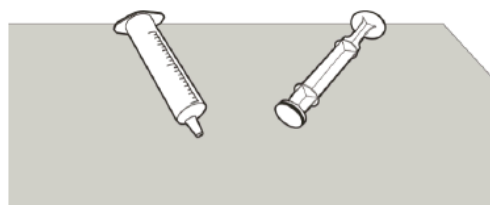

Figure U

**Step E3**

Check that the oral syringe barrel and plunger are clean.

Place the oral syringe barrel and plunger on a clean surface in a safe place to dry (See Figure U).

Wash your hands.

Once dry, reassemble the plunger into the oral syringe barrel and store the syringe with your medicine.

## Instruction for Constitution

**Evrysdi® 0.75 mg/ml**

**powder for oral solution**

**Risdiplam**

## Instructions for Constitution

### (FOR PHARMACISTS ONLY)

Each Evrysdi carton contains (See figure A):

1. 1 Cap
2. 1 Evrysdi bottle
3. 2 Oral syringes 12 mL (in pouches)
4. 2 Oral syringes 6 mL (in pouches)
5. 1 Press-in bottle adapter
6. 1 Professional Information (not shown)
7. 1 Instructions for Constitution (not shown)
8. 1 Instructions for Use (not shown)

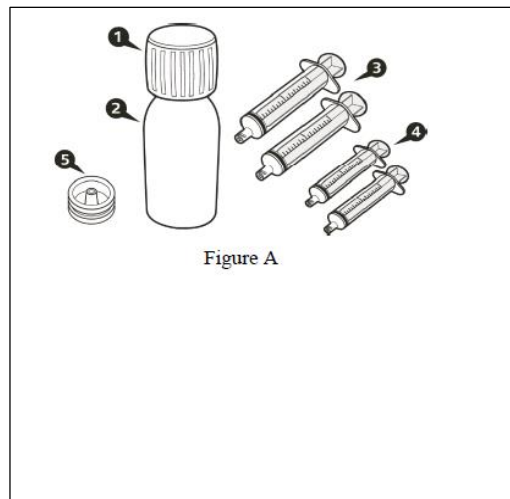

### **Important information about Evrysdi**

- **Avoid inhaling** Evrysdi powder
- **Use gloves.**
- **Do not** use if the powder expiry date has passed. The powder expiration date is printed on the bottle label.
- **Do not** dispense the constituted solution of the solution's Discard After date exceeds the original powder expiration date.
- **Avoid getting contact** with the medicine on your skin. If the medicine gets on your skin, wash the area with soap and water.
- **Do not** use the medicine if any of the supplies are damaged or missing.
- Use Purified Water or Sterile Water for Injection (SWFI) to constitute the medicine.

- Do not add oral syringes other than the ones provided in the carton.

### How to store Evrysdi

- Store the powder (unconstituted medicine) at room temperature and keep it in the carton.
- Store the solution (constituted medicine) in a refrigerator between 2°C to 8°C and keep it in the carton upright.
- Keep the oral solution in the original bottle and always keep the bottle in an upright position with the cap tightly closed.

### Constitution

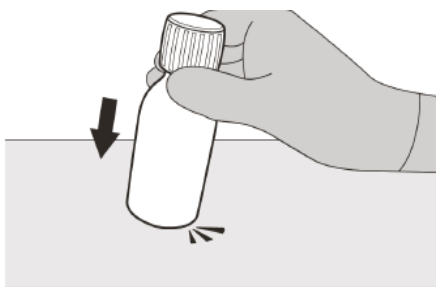

Figure B

#### Step 1

Gently tap the bottom of the bottle to loosen the powder (See Figure B).

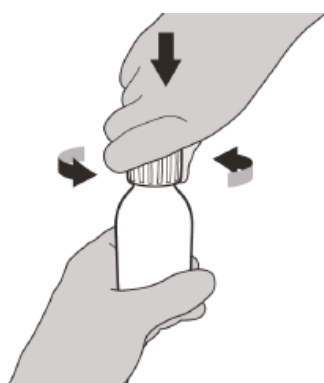

Figure C

#### Step 2

Remove the cap by pushing it down and then twisting to the left (counter-clockwise) (See Figure C). Do not throw away the cap.



Figure D

### Step 3

Carefully pour 79 mL of Purified water or Sterile Water for Injection (SWFI) into the medicine bottle (See Figure D).

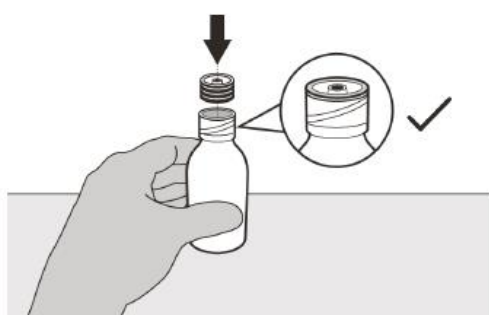

Figure E

### Step 4

Hold the medicine bottle on a table with one hand.

Insert the press-in bottle adapter into the opening by pushing it down with other hand. Ensure it is completely pressed against the bottle lip (See Figure E).

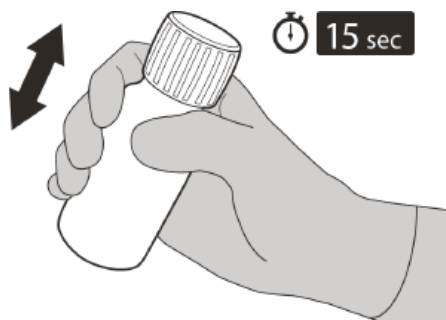

Figure F

### Step 5

Put the cap back on the bottle. Turn the cap to the right (clockwise) to close the bottle.

Ensure it is completely closed and then shake well for 15 seconds (See Figure F).

Wait for 10 minutes. You should have obtained a **clear solution**.

If not, shake well again for another 15 seconds.



Figure G

### Step 6

Calculate the Discard After date **as 64 days** after constitution is counted as day 0. For example, if constitution is on the the 1<sup>st</sup> of April, the Discard After date will be the 4<sup>th</sup> of June).

**Write the Discard After date** of the solution on the bottle label (See Figure G) and carton.

Put the bottle back in its original carton, with syringes (in pouches), Professional Information and Instruction For Use booklet. Store the carton into the refrigerator.